

THIS MAP WAS PREPARED FOR ASSESSMENT PURPOSE ONLY

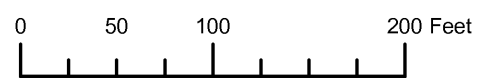

SW1/4 SE1/4 SECTION 02 T.30S. R.46E. W.M.
MALHEUR COUNTY
1" = 100'

30S 46E 02DC

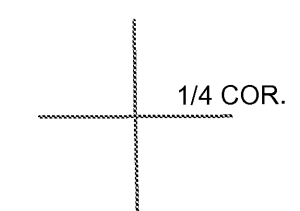
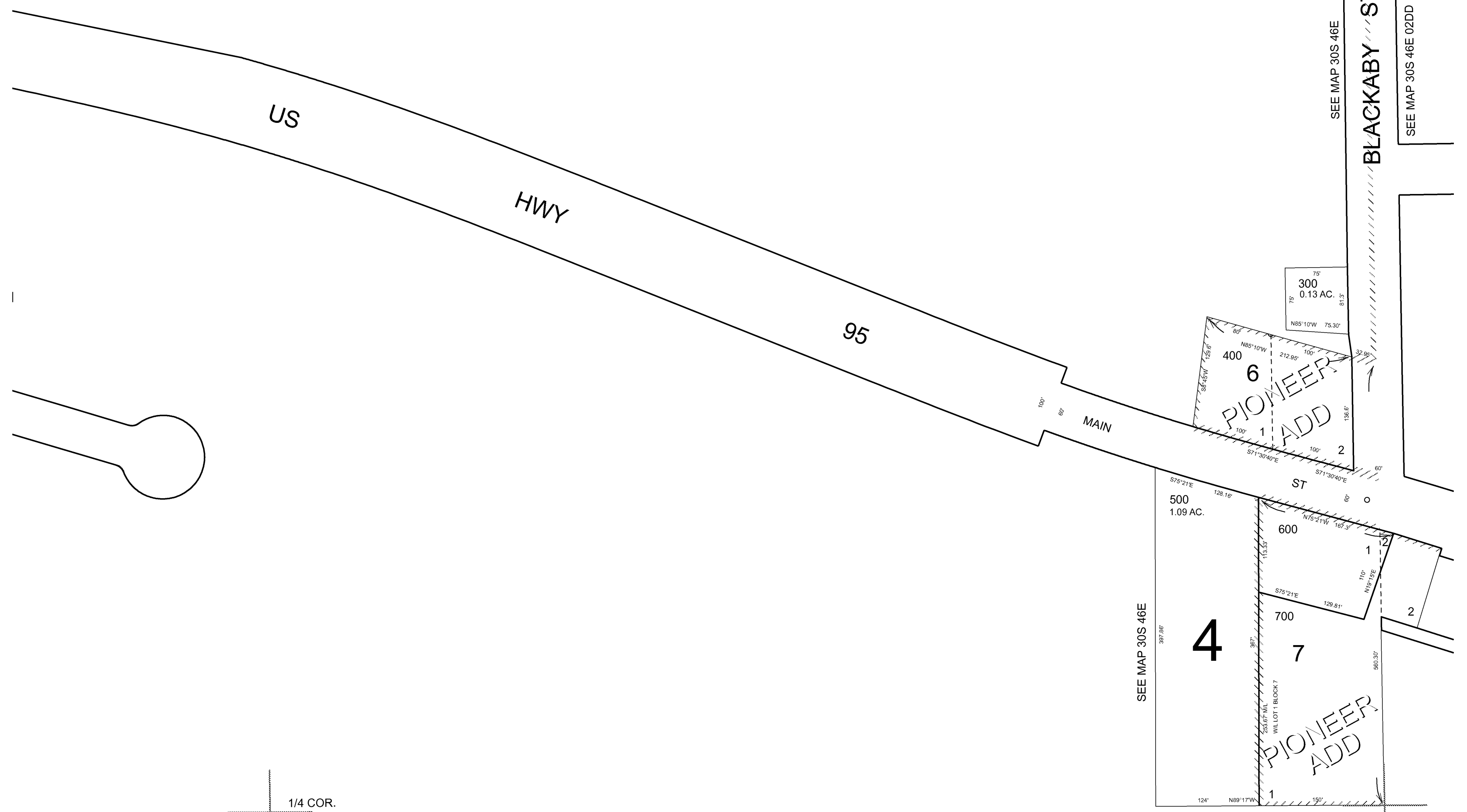
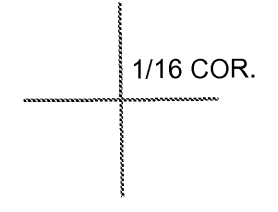

SEE MAP 30S 46E 02DB 1/16 COR.

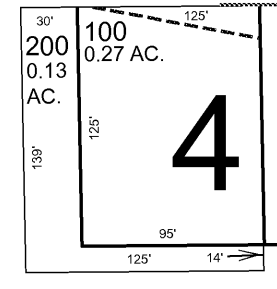

4

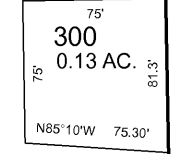

300
0.13 AC.

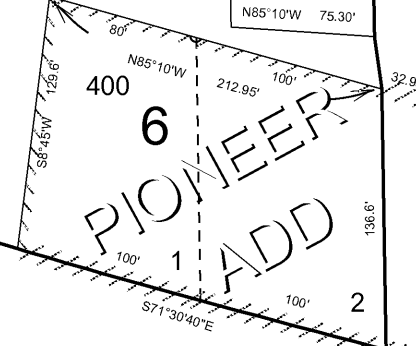

400

PIONEER ADD

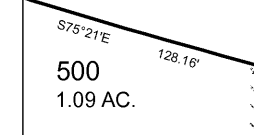

500
1.09 AC.

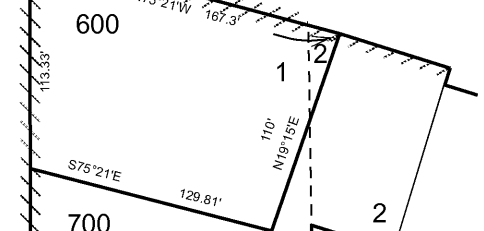

600

PIONEER ADD

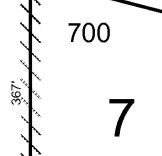

700

7

SEE MAP 30S 46E

4

SEE MAP 30S 46E 1/16 COR.